

XXX

X 0 mm

Y 0 mm

Z 0 mm

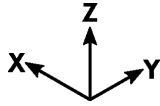

X 600 mm

Y 500 mm

Z 370 mm

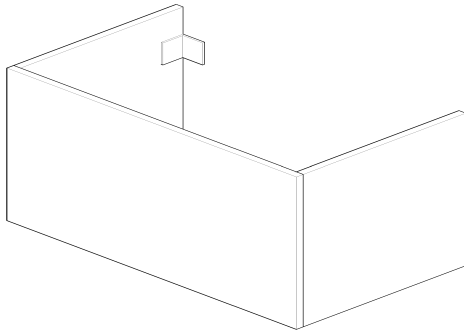

- A mm
- B mm
- C mm
- D mm
- E mm
- F mm
- G mm
- H mm
- I mm
- J mm
- M 71 mm
- N mm

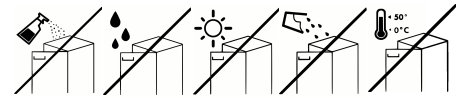
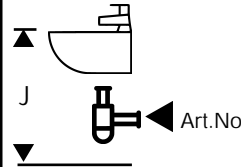
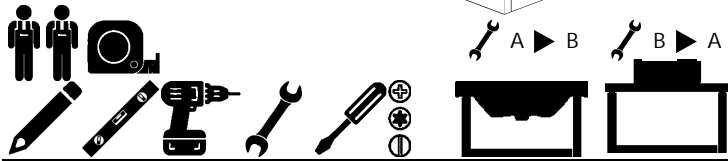
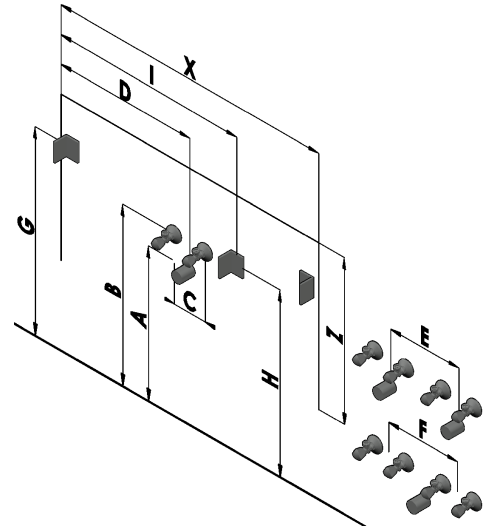

A

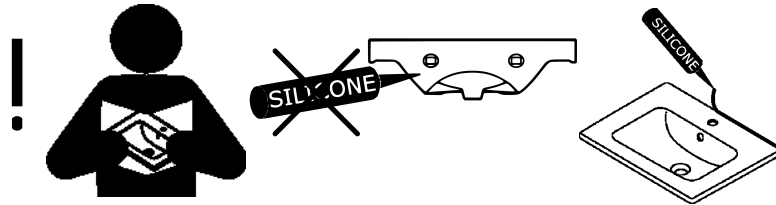

B

