

# JOCKAM SZZ2 100 U103



U103

X<sub>1</sub> 460mm

Y<sub>1</sub> 390mm

Z<sub>1</sub> 125mm

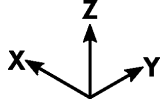

X 1000 mm

Y 500 mm

Z 418 mm

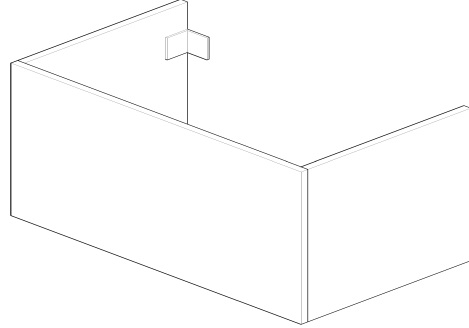
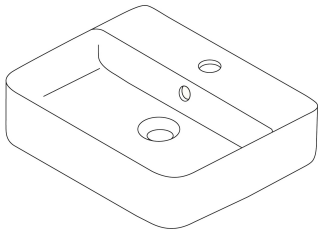

- A 560 mm
- B 600 mm
- C 80-120 mm
- D 500 mm
- E --- mm
- F --- mm
- G 656 mm
- H --- mm
- I --- mm
- J 860 mm
- M mm
- N mm

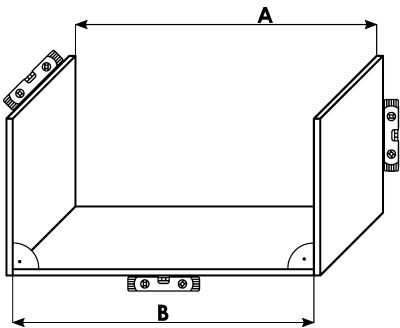
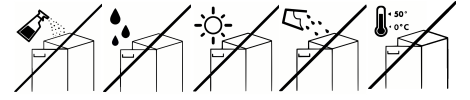
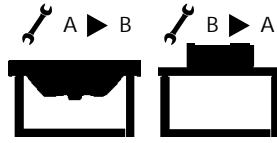
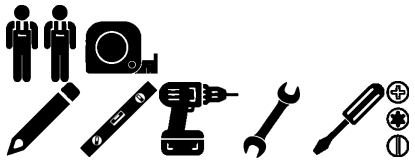

! A=B

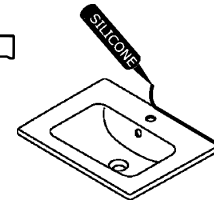
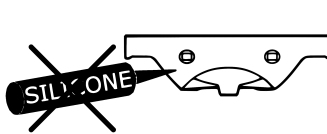
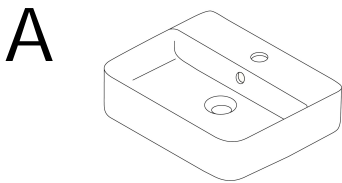

B

